

Notes:

1. Ice maker unit should be placed indoors with thorough ventilation on four sides;
2. At least 1 meter away from the four sides is required for operation and maintenance space and the user should be responsible for the unit's base;
3. Water inlet and outlet, power supply cables and refrigeration pipelines should be connected to the designated interfaces by customers on site;
4. The unaccounted should be subject to our standards while others as per actual design;
5. The drawing is for reference only and the supply range should be subject to the contract;
6. The position and size of the installation hole is only for reference and should be subject to actual design.

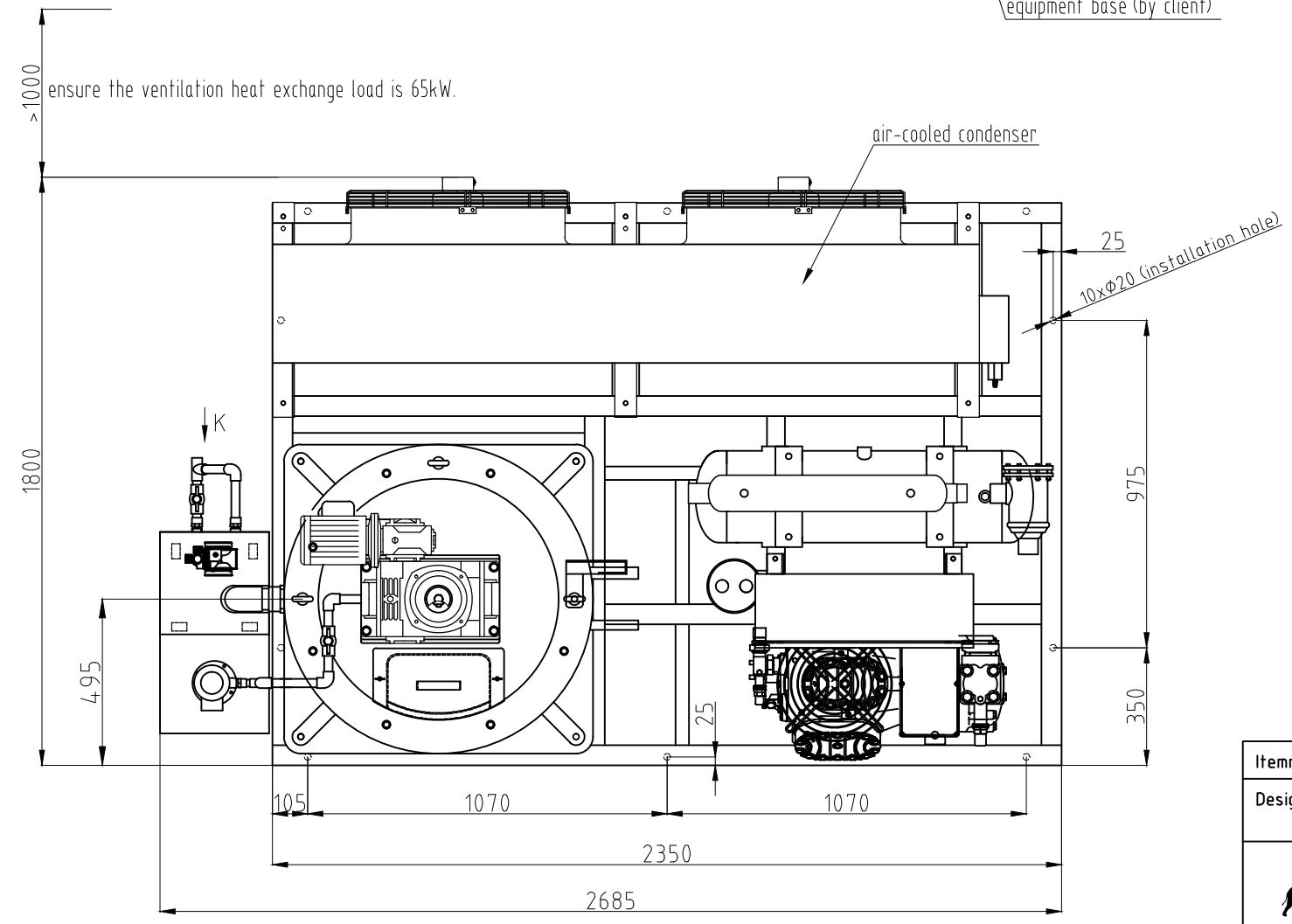

Technical parameter:

water inlet temp.	16 °C
ambient temp.	32 °C
wet bulb temp.	25 °C
nominal ice output	5t/24hr
power supply	3P/380V/50Hz
refrigerant	R404A
installation power	about 30kW
ice maker water consumption	0.21m ³ /hr
unit overall dimension	about 2685x1800x1471mm
unit running weight	about 1.8t

Itemref	Quantity	Title/Name, designation, material, dimension etc			Article No./Reference	
Designed by	Checked by	Approved by - date	File name	Date	Scale	
			5T FLAKE ICE MACHINE			
			RECOM F50AS-5	Edition	Sheet	